

CIR-KIT™
BREADBOARD BUNDLE

MOSFET BOOST

BUILD GUIDE

INCLUDED COMPONENTS

Potentiometers



B5K
x1

Precut Wire



1.5" Red, Black, Green, Blue
x40

Transistors & Capacitors



Transistor
2n7000
x1



Film Caps
(various)
x3

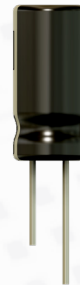

Electrolytic Cap
(various)
x2

Resistors & Diodes



Resistors
10K
x3



Resistors
2.2M
x2

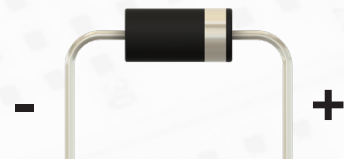

Diode
1n4001
x1

BREADBOARD FLOW

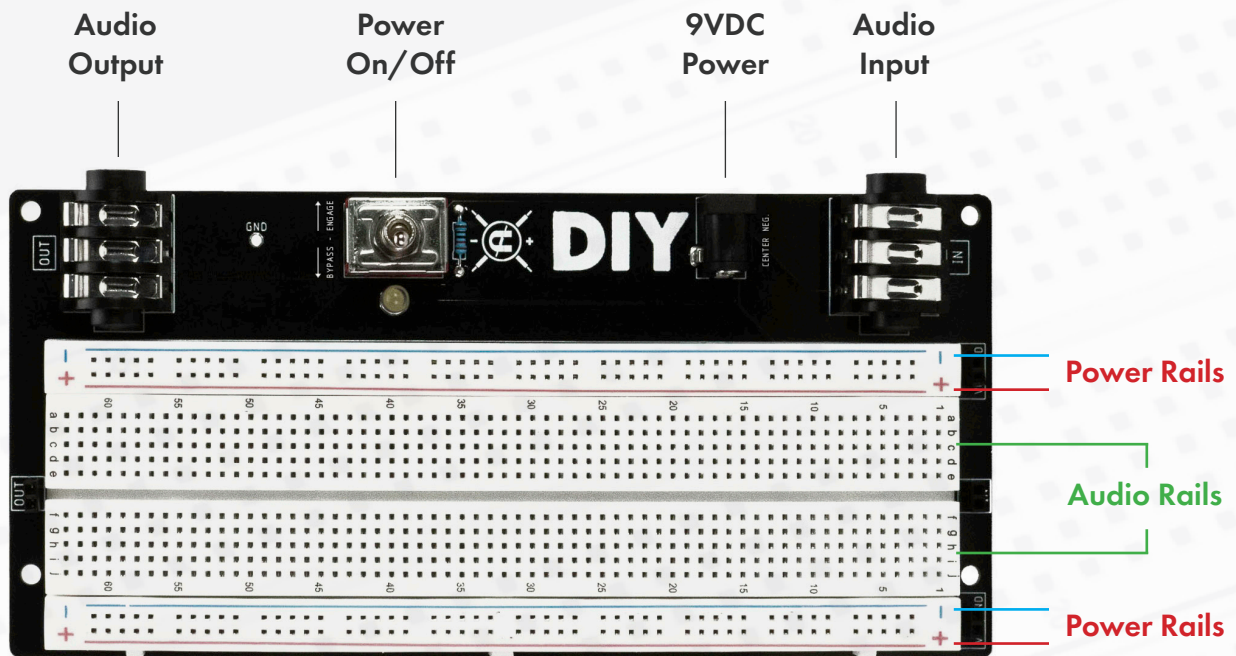

Power rails flow horizontally.

The **negative** rail will connect to the pin header marked **GND**, and the **positive** rail will connect to the pin header marked **VCC**.

Audio rails flow vertically.

Channels **a-e** are connected, and channels **f-j** are connected.

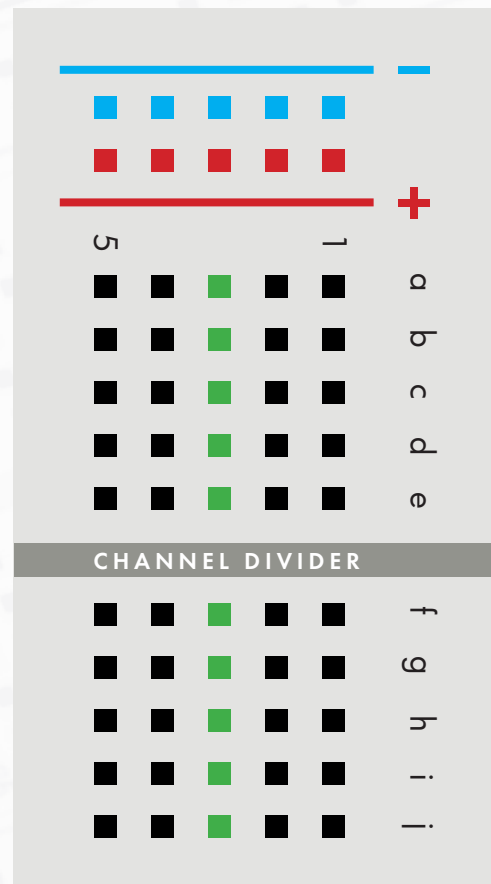

READING RESISTORS

Reading resistors may seem intimidating, but it's a very important aspect of breadboarding and is actually very easy! To determine the resistor value, follow the table and colors below. To ensure you are reading the correct value, keep in mind that the tolerance band is always found on the far right.



COLOR	1ST BAND	2ND BAND	3RD BAND	DECIMAL MULTIPLIER		TOLERANCE	
BLACK	0	0	0	1	1		
BROWN	1	1	1	10	10	±	1%
RED	2	2	2	100	100	±	2%
ORANGE	3	3	3	1K	1,000		
YELLOW	4	4	4	10K	10,000		
GREEN	5	5	5	100K	100,000		
BLUE	6	6	6	1M	1,000,000		
VIOLET	7	7	7	10M	10,000,000		
GRAY	8	8	8		100,000,000		
WHITE	9	9	9		1,000,000,000		
GOLD					0.1	±	5%

Shown below are the resistors and values that we'll be using in this build.

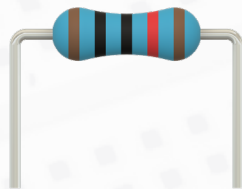

10K



2.2M

STEP 1 | POWER FILTERING

Power filtering helps to filter unwanted noise from power supplies, while preventing incorrect polarity from damaging the circuit. Ensure that polarized components (diode + electrolytic capacitor) are inserted correctly. In the schematic below, the power shows 9V, whereas the breadboard shows VCC. Please note that for the majority of pedal circuits, these terms are interchangeable.

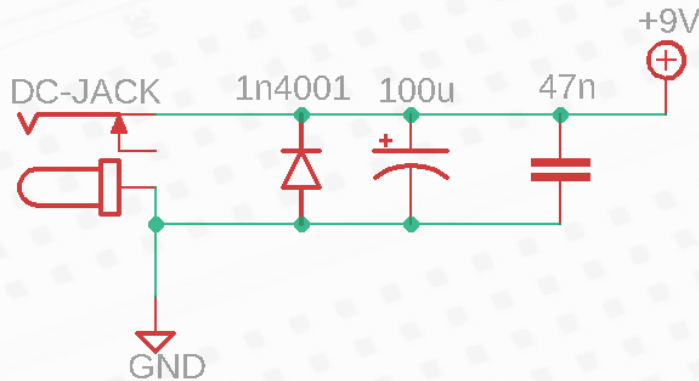

1.5" Red
x1



1.5" Black
x1



1N4001
x1



100u
x1



47n
x1

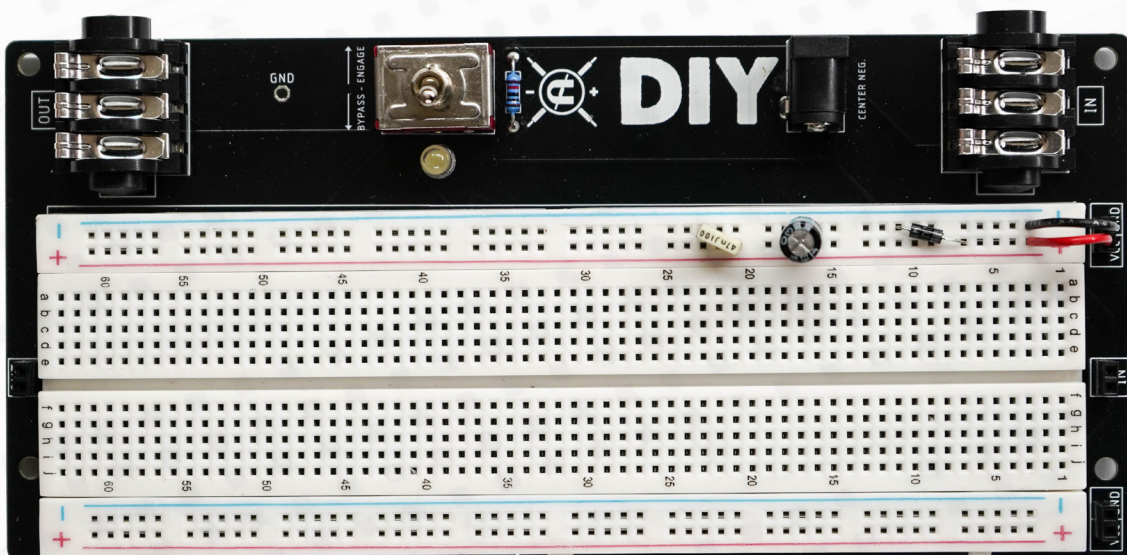

STEP TWO | INPUT

The input capacitor blocks AC signal, while setting the amount of low frequency audio allowed into the circuit. The pull down resistor prevents popping from the switch.

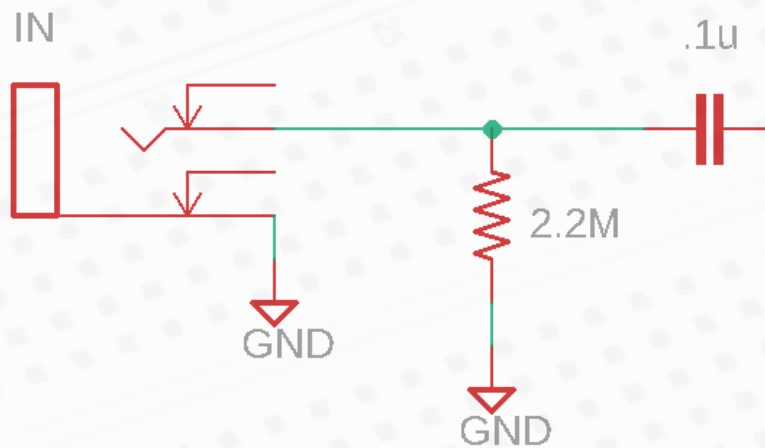

1.5" Green
x1



2.2M
x1



.1u
x1

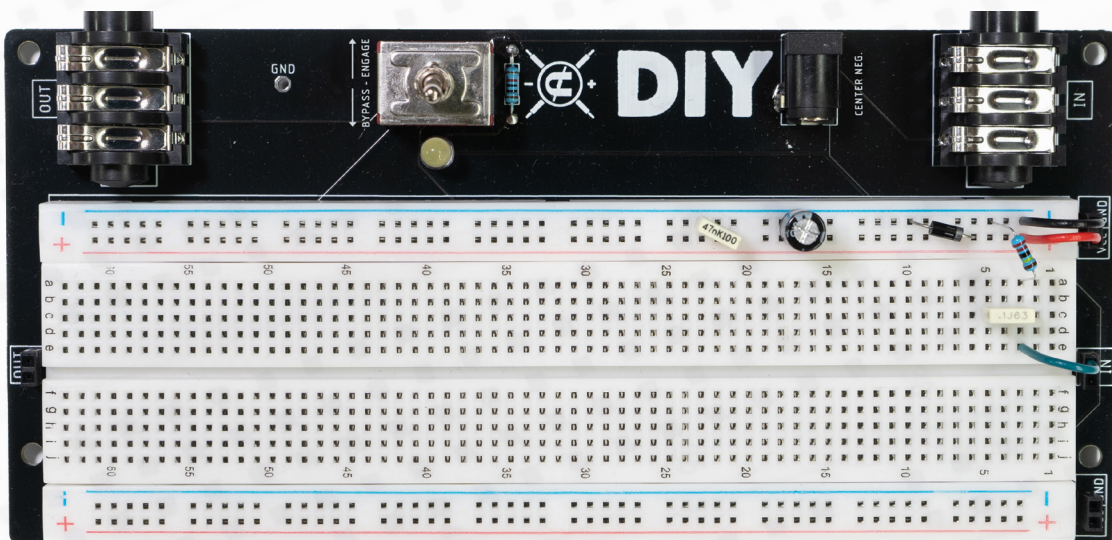

STEP THREE | GAIN SECTION

These resistors set the voltage biases of the transistor, allowing it to function as desired.

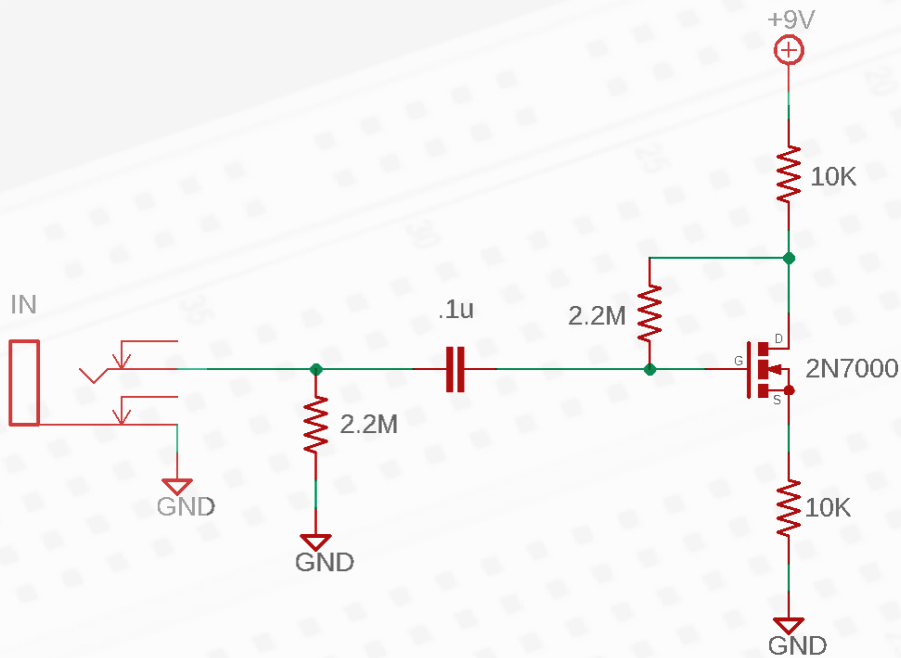

MOSFET PINOUT



S G D

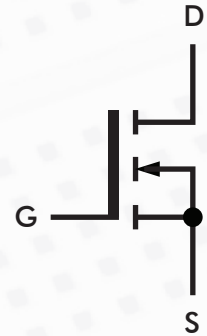

1.5" Green
x2



10K
x2



2.2M
x1



2n7000
x1

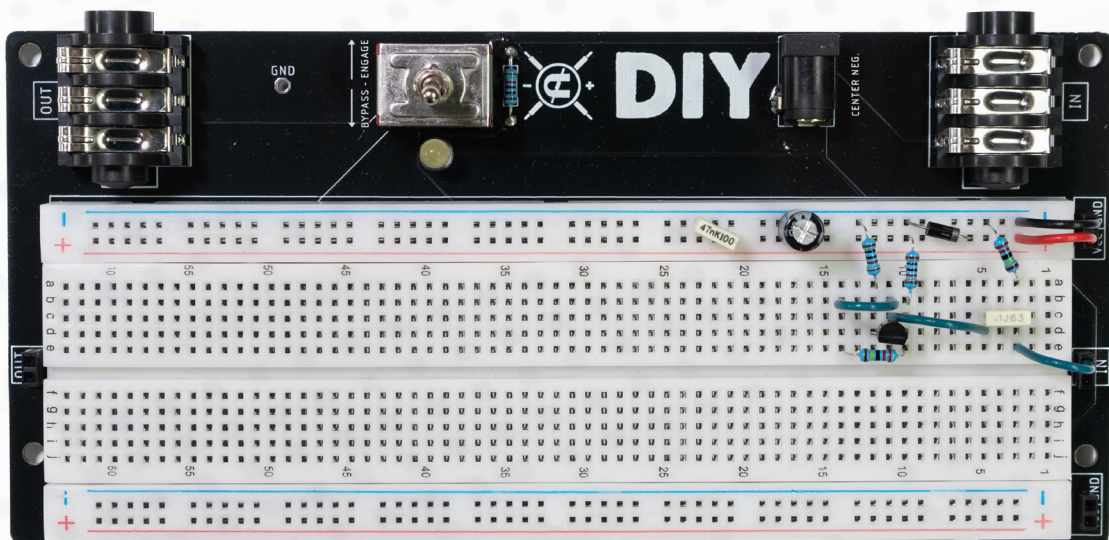

STEP FOUR | VOLUME CONTROL

The potentiometer attached to the transistor (through the electrolytic capacitor) changes the fixed bias established in step 3, increasing output volume.

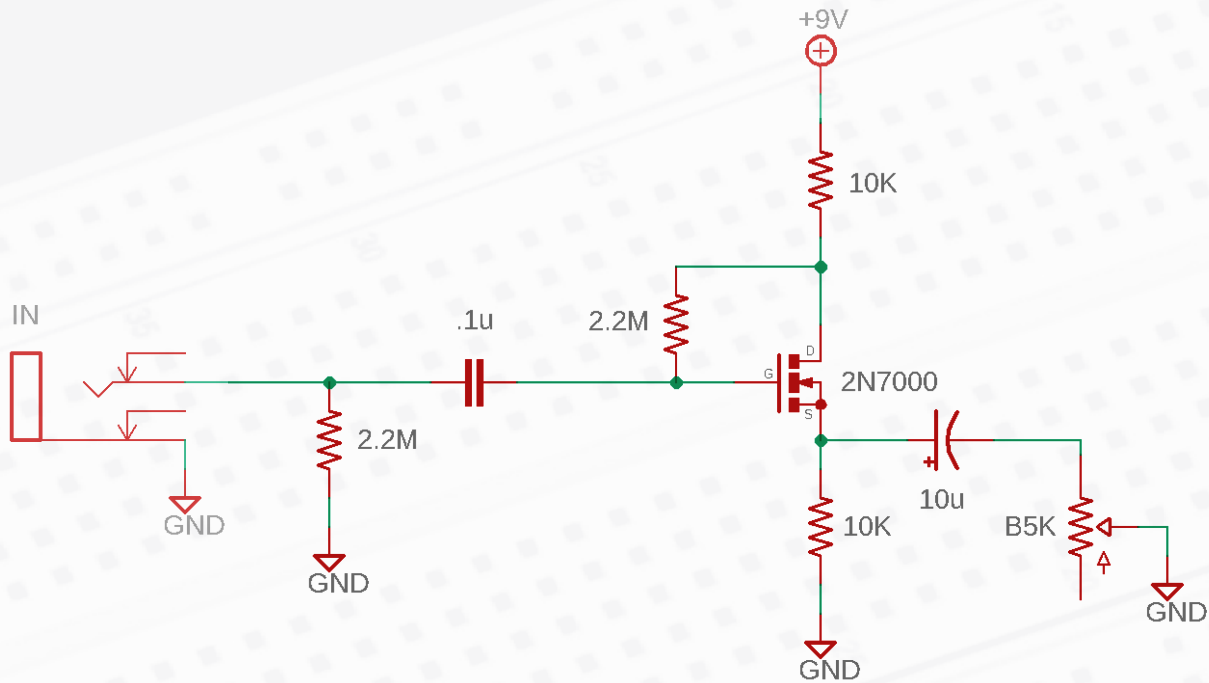

10u
x1

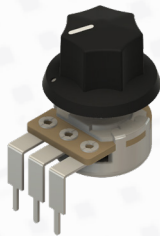

B5K
x1



1.5" Black
x2



1.5" Green
x1

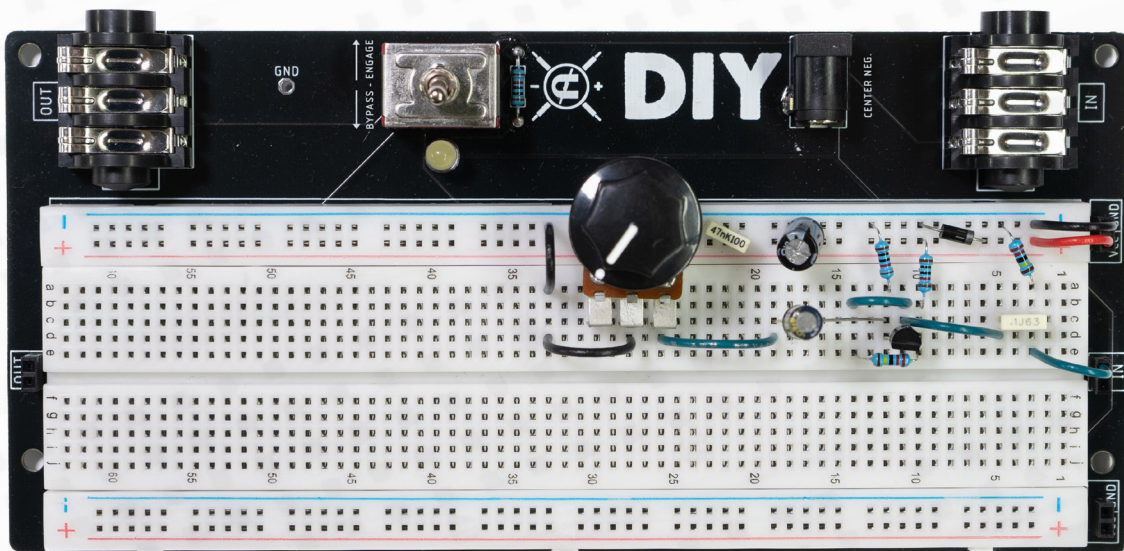

STEP FIVE | OUTPUT

Make the final connections from the transistor to the output through the film capacitor, completing the circuit.

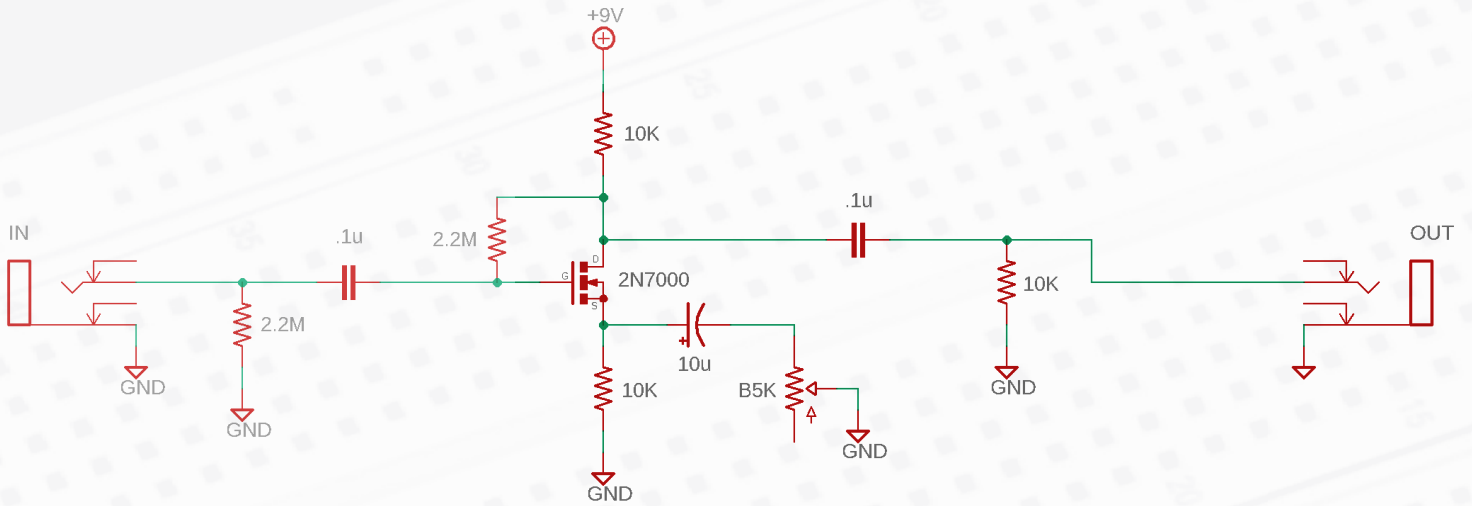

.1u
x1



10K
x1



1.5" Blue
x8

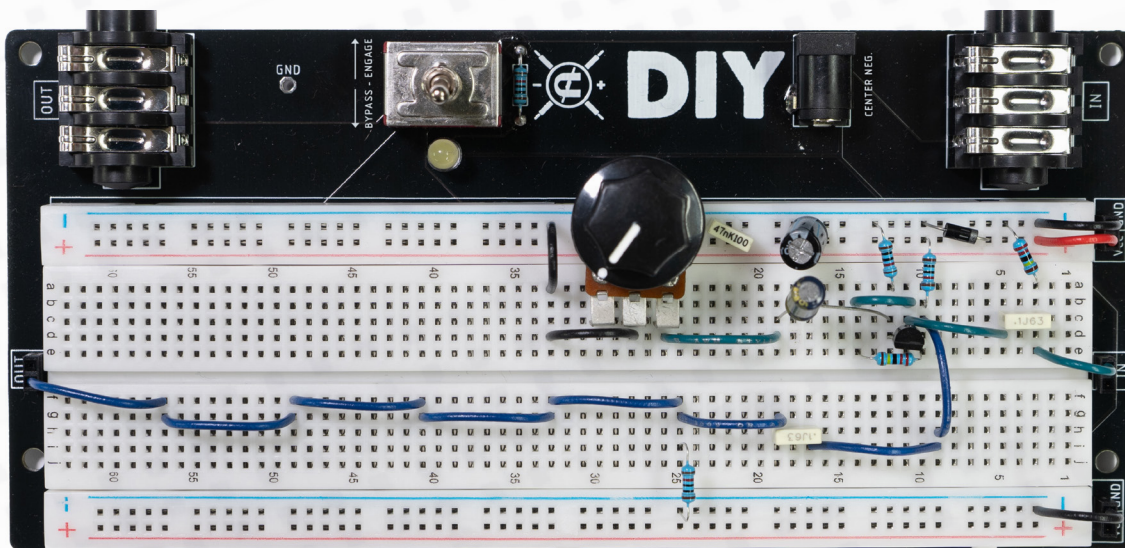

TROUBLESHOOTING

Not getting power to the Power Rails/LED is not turning on when the toggle switch is set to the 'Engage' position.

Check that the proper connections are being made from the "VCC" & "GND" pin headers to the Power Rails. Pay attention to the orientation of Polarized components (Diodes and Electrolytic Capacitors).

Check the polarity of your power supply. Breadboards require "Center negative" polarity (as is with the power supply shipped with the bundle).

Not getting any effect when the toggle switch is set to the Engage position.

Most common issues will pertain to the proper connections being made. This could be as simple as a component being 1 slot away from the correct Audio Rail.

Check that transistors are in the correct orientation, and not flipped around 180 degrees.

Getting effect when toggle switch is set to Engage, but it doesn't sound as expected.

Check that the transistor is in the correct orientation and not flipped around 180 degrees. Check that the resistors are in the correct place and didn't get swapped with a different value. Pay attention to the orientation of Polarized components (Diodes and Electrolytic Capacitors).

Still stuck? Please reach out to us with any questions you have! We're here to help. Please email us at: diy@coppersoundpedals.com

